













## Dati Tecnici - Specifications

											
	cond	comp. W	ABS. W	Fuse	Kwh/100Kg	l / h	kg	Lbs	kg	Lbs	Ton CO2 equiv.
<b>CS50 A</b>		1161	680	10	32.4	4.60	48	106	56	123	0.50
<b>CS50 W</b>		1161	630	10	20.4	39.7	48	106	56	123	0.43

## 24h Produzione Ghiaccio - Ice Production

### Raffreddamento ad aria - Air Cooled Unit

Temp. aria Air Temp.	Temp. acqua / Water Temp.			
	32°	21°	15°	10°
°C	32°	21°	15°	10°
°F	90°	70°	60°	50°
10°	<b>47</b>	<b>49</b>	<b>50</b>	<b>52</b>
50°	104	108	110	115
21°	<b>41</b>	<b>43</b>	<b>45</b>	<b>47</b>
70°	90	95	99	104
32°	<b>33</b>	<b>35</b>	<b>37</b>	<b>39</b>
90°	73	77	82	86
38°	<b>27</b>	<b>30</b>	<b>32</b>	<b>34</b>
100°	60	66	71	75

### Raffreddamento ad acqua - Water Cooled Unit

Temp. aria Air Temp.	Temp. acqua / Water Temp.			
	32°	21°	15°	10°
°C	32°	21°	15°	10°
°F	90°	70°	60°	50°
10°	<b>48</b>	<b>50</b>	<b>52</b>	<b>54</b>
50°	106	110	115	119
21°	<b>44</b>	<b>47</b>	<b>49</b>	<b>51</b>
70°	97	104	108	112
32°	<b>42</b>	<b>45</b>	<b>47</b>	<b>49</b>
90°	93	99	104	108
38°	<b>40</b>	<b>43</b>	<b>45</b>	<b>47</b>
100°	88	95	99	104

Vista frontale  
Front view

Vista laterale  
Lateral view

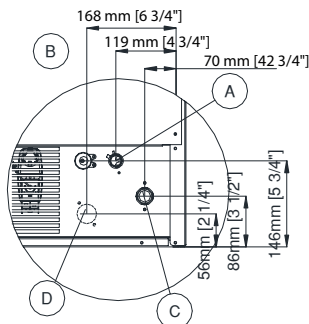
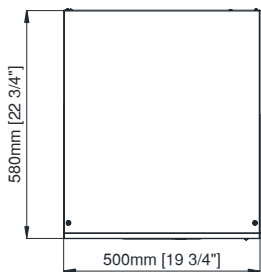
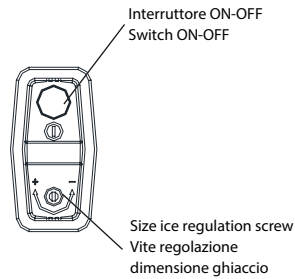
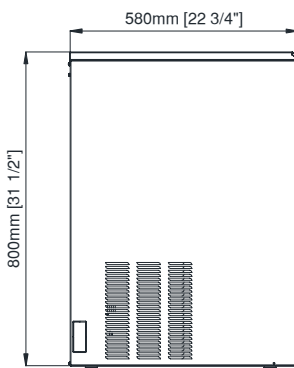
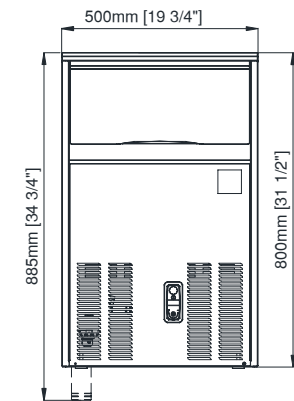

**(A)** Electrical cable supply / Ingresso alimentazione elettrica

**(B)** Water outlet connection / Attacco scarico acqua diam. 20 mm

**(C)** Water inlet connection / Attacco entrata acqua - 3/4" gas

**(D)** Water outlet connection water condensation / Uscita acqua condensatore ad acqua diam. 20 mm

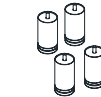

Kit 4 Feet Optional  
Kit 4 piedini Optional  
Ø50mm H100-120 mm



### PANNELLO DI CONTROLLO - CONTROL PANEL



### CAPACITA' DEPOSITO - BIN CAPACITY

22 Kg - 48.5 lbs / 1100 pcs

### DIMENSIONI - DIMENSIONS

LxPxH(mm): 500 x 580 x 800

WxDxH(in): 20" 11/16 x 23" 13/16 x 31" 8/16

### DATI SPEDIZIONE / SHIPPING DATA

LxPxH(mm): 560 x 600 x 850

WxDxH(in): 22" 1/16 x 25" 3/16 x 38" 13/16

### TIPO GHIACCIO - ICE TYPE

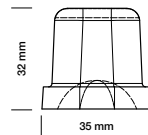

**20g**  
PESO GHIACCIO  
WEIGHT ICE

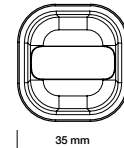

**36**  
PZ / CICLO  
PCS / CYCLE

### CONDIZIONI USO-OPERATING REQUIREMENTS



220-240V / 50Hz / 1



R134a GWP=1430

MIN

MAX

10°C (50°F)



40°C (104°F)

5°C (41°F)



35°C (95°F)

- 10 %



+ 10 %

1 BAR (14 PSI)



5 BAR (70 PSI)

Calore espulso - Rejected Heat  
Volume aria - Air Volume

**1750 W**  
**310 m3/h**